

**Features:**



- ◆ 1:1CT Impedance
- ◆ Impedance: 50 Ω & 75 Ω
- ◆ Frequency: 5 to 200 MHz
- ◆ RF power: 0.5W
- ◆ DC current: 300mA
- ◆ Operating temperature range: -40°C to +85°C
- ◆ Storage temperature range: -55°C to +100°C



**Applications:**

- ◆ For broadband and wireless communications
- ◆ For VHF/UHF receivers/transmitters and push-pull amplifiers

**Dimension Diagram (Unit:mm) :**

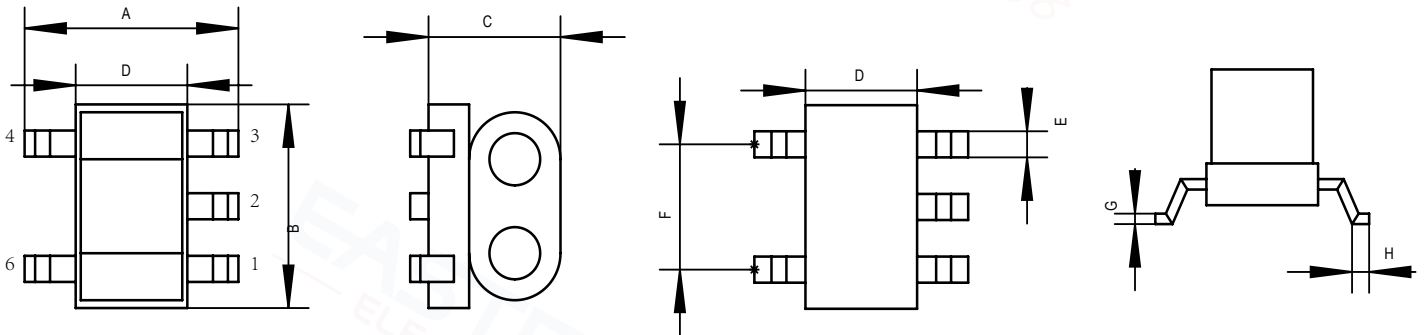

A=6.20±0.20 B=6.00±0.20 C=4.30±0.20 D=4.00±0.20 E=0.60±0.10 F=4.00±0.10 G=0.25±0.10 H=0.50±0.10

**Electrical structure:**

**Recommended layout:**

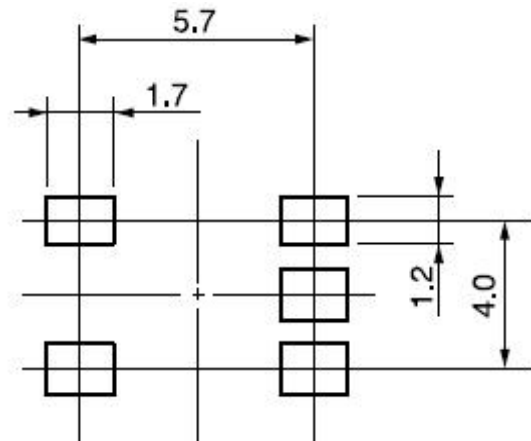
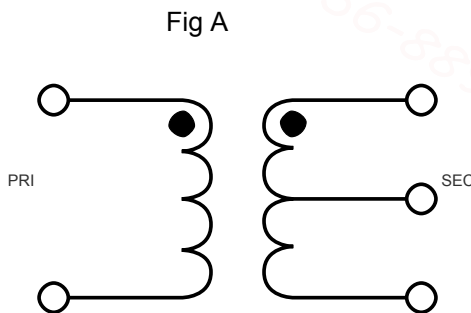

**Pin configuration:**

Pin No.	Function
1	Output2
2	Ground
3	Output1
4	Input
6	Ground

**Application circuit :**

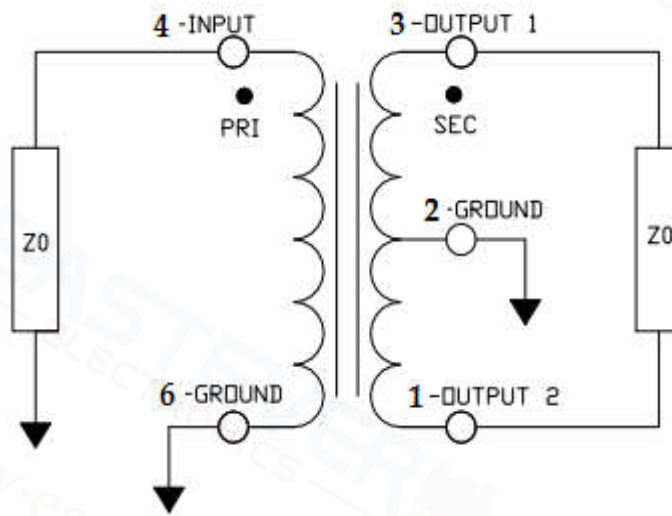

**Electrical Specifications: TA=25°C, 0dBm, Z0=75Ω:**

Parameter	Test Conditions	Units	Min	Typ	Max
Main line Loss(out1)	5-200MHz	dB	—	0.5	1.0
Main line Loss(out2)	5-150MHz	dB	—	0.8	2.0
Main line Loss(out2)	150-200MHz	dB	—	0.7	2.0
Amplitude Balance	5-200MHz	dB	—	0.3	±0.5
Phase Balance	5-200MHz	Degrees	—	2.0	±7.0
Input Return Loss	5-200MHz	dB	8.0	20.0	—

Main line Loss(out1)

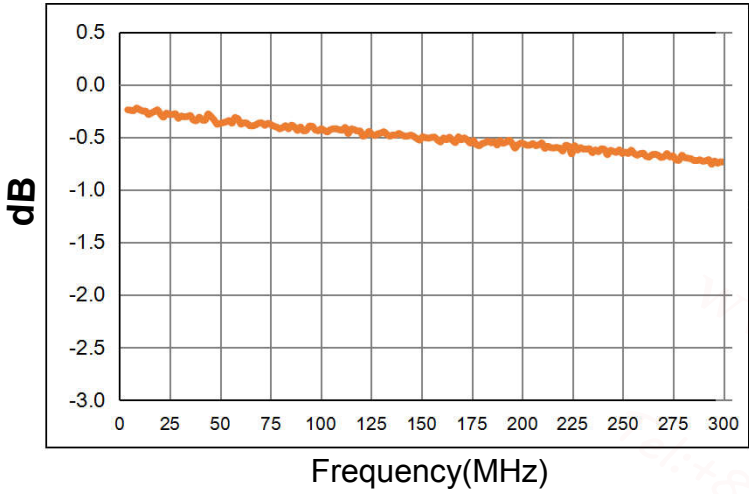

Main line Loss(out2)

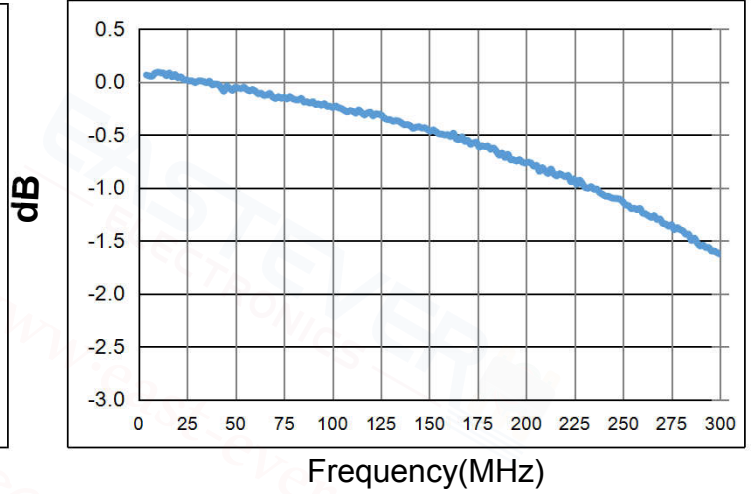

Amplitude Balance

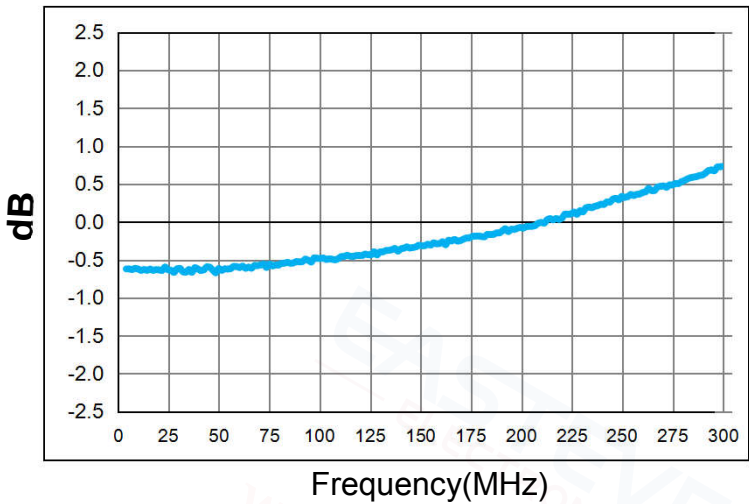

Phase Balance

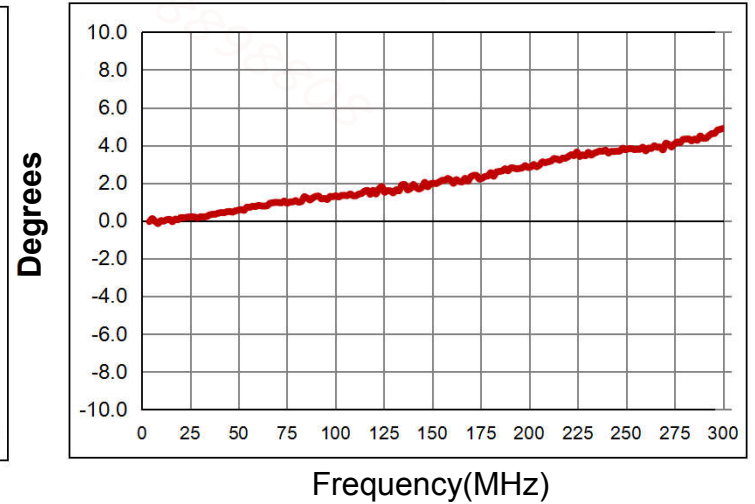

Input Return Loss

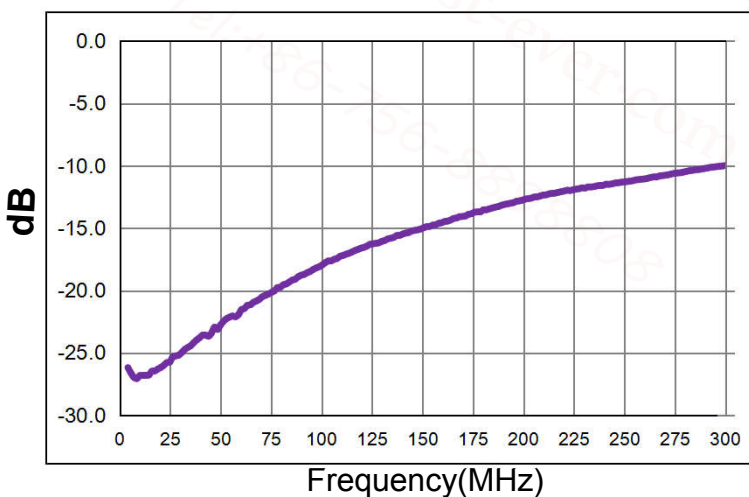

Recommended Soldering Temperature Graph:

Typical RoHS Reflow Profile

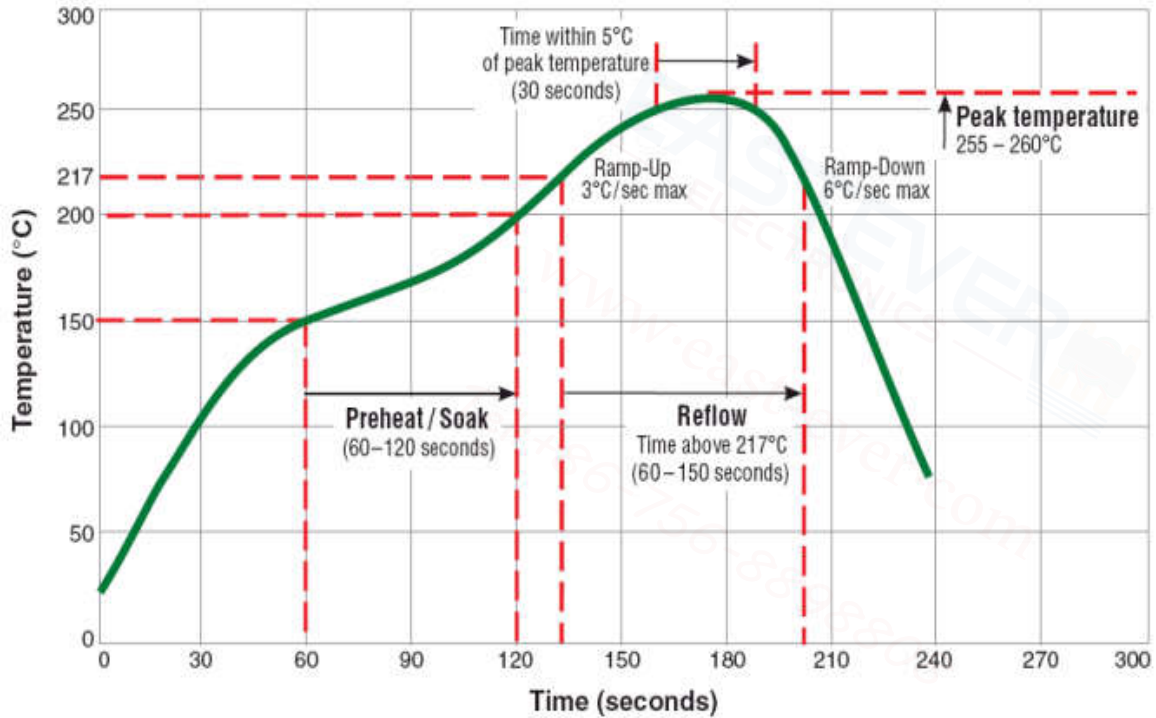

Packaging Dimension For Caeier Tape(UNIT:mm):

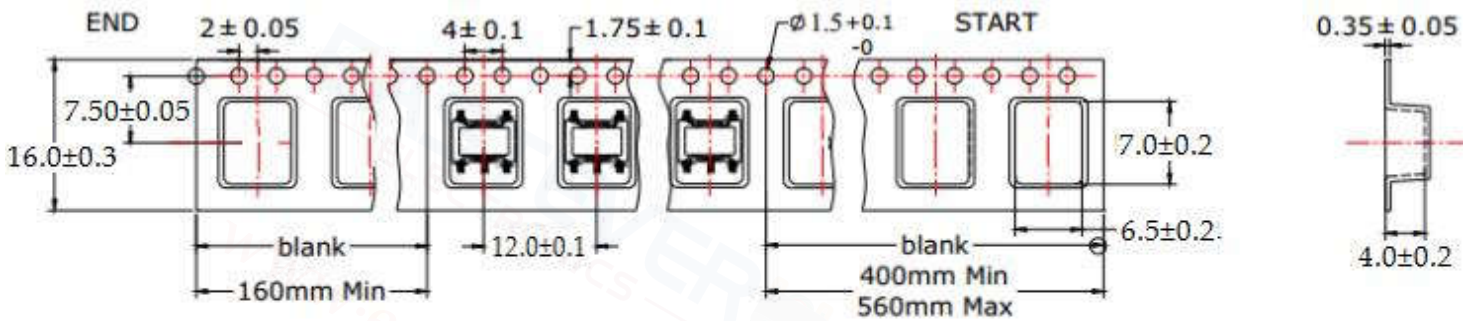

<b>QUANTITY</b>
1000PCS/Reel
3Reels/Middle Carton Middle Carton:
4 Middle Cartons/Big Carton
12000PCS/ Big Carton

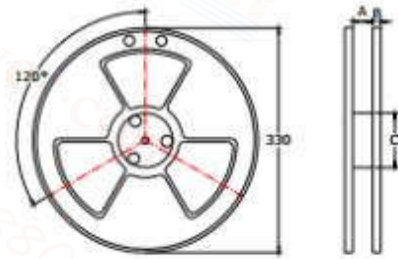

SPEC	8	12	16	24
DIM A±0.1	8.5	12.5	16.5	24.5
DIM B±0.1	2.3	2.3	2.3	2.3
DIM C±0.1	100	100	100	100

