



Features:

- ◆ 1: 1 Impedance
- ◆ 75 Ω Characteristic Impedance
- ◆ Frequency: 5 to 100 MHz
- ◆ RF power: 0.50W
- ◆ DC current: 30mA
- ◆ Insertion loss: 2.0dB Max; Input Return loss: 10.0dB Min
- ◆ Operating temperature range: -40°C to +85°C
- ◆ Storage temperature range: -55°C to +100°C



Applications:

- ◆ For broadband and wireless communications
- ◆ For VHF/UHF receivers/transmitters and push-pull amplifiers

Dimension Diagram (Unit:mm) :

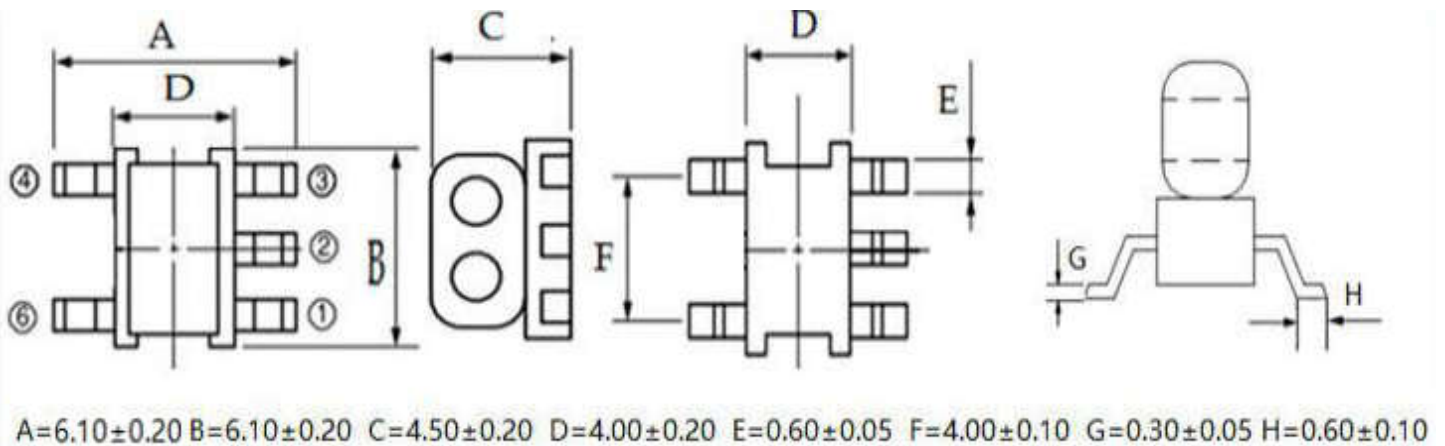

Electrical structure:

Recommended layout:

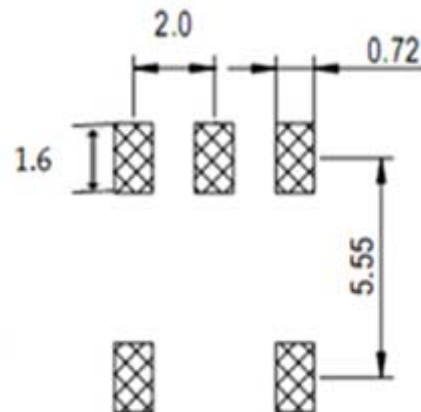
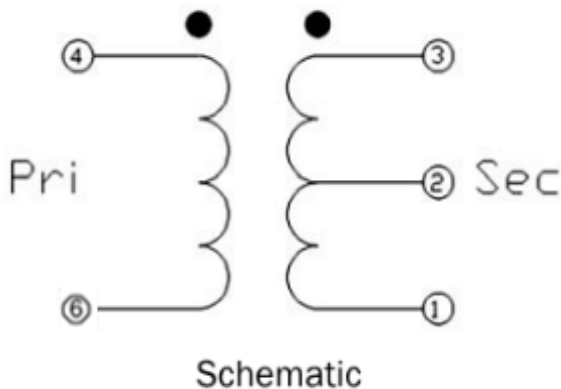

Pin configuration:

Pin no.	Function
1	Secondary dot (Output 1)
2	Not connected
3	Secondary (Output 2)
4	Primary (Ground)
6	Primary dot (Input)

Application circuit :

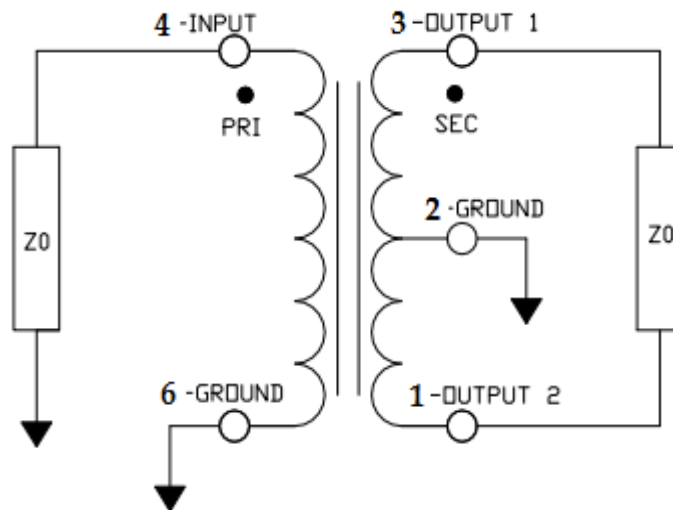

Electrical Specifications: TA=25°C, 0dBm,Z0=75Ω

Parameter	Test Conditions	Units	Min	Typ	Max
Main line Loss(out1)	5-100MHz	dB	—	0.5	1.5
Main line Loss(out2)	5-100MHz	dB	—	1.0	2.0
Amplitude Balance	5-100MHz	dB	—	±0.5	±0.5
Phase Balance	5-100MHz	Degrees	—	±1.0	±3.0
Input Return Loss	5-100MHz	dB	10.0	15.0	—

Main line Loss(out1)

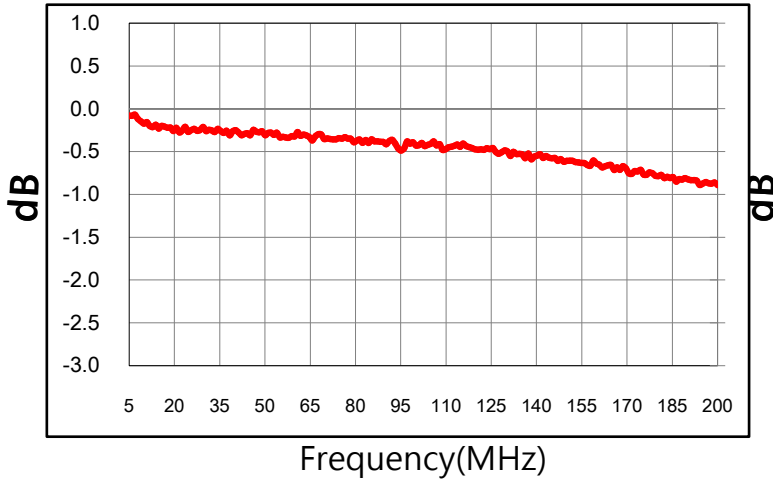

Main line Loss(out2)

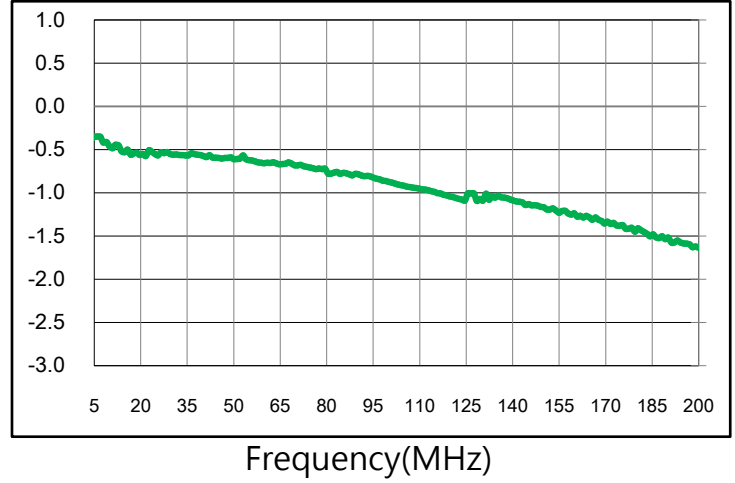

Amplitude Balance

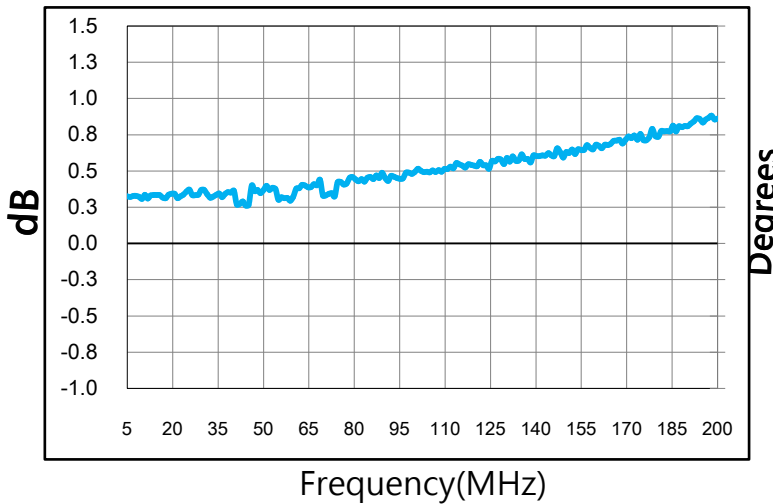

Phase Balance

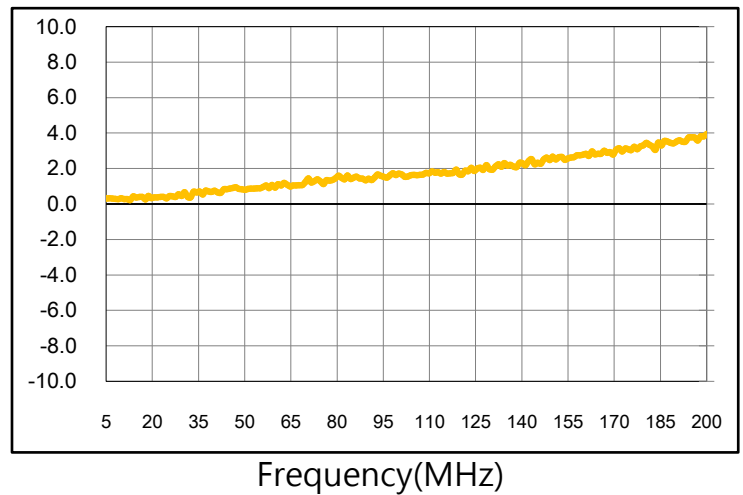

Input Return Loss

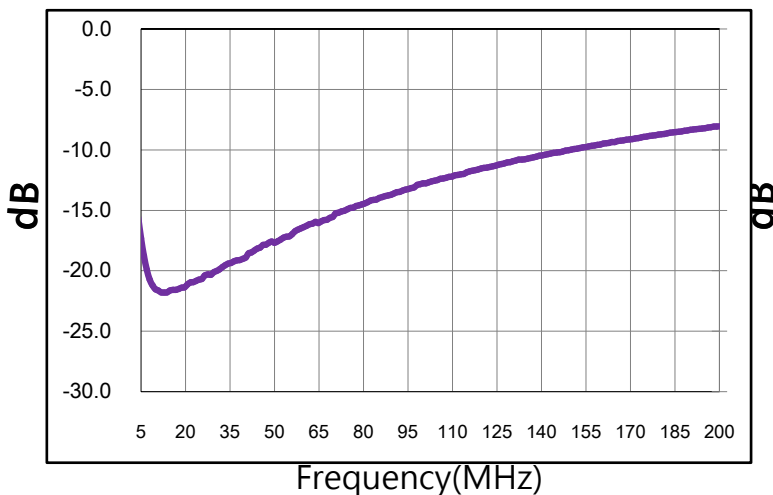

Sdd22

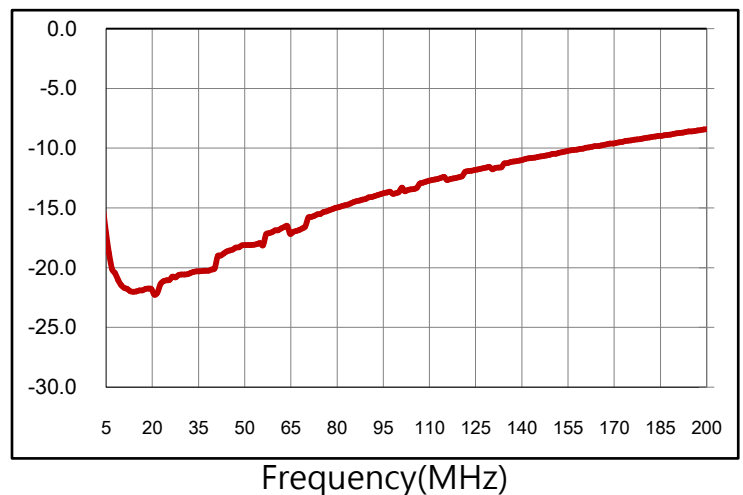

Recommended Soldering Temperature Graph:

Typical RoHS Reflow Profile

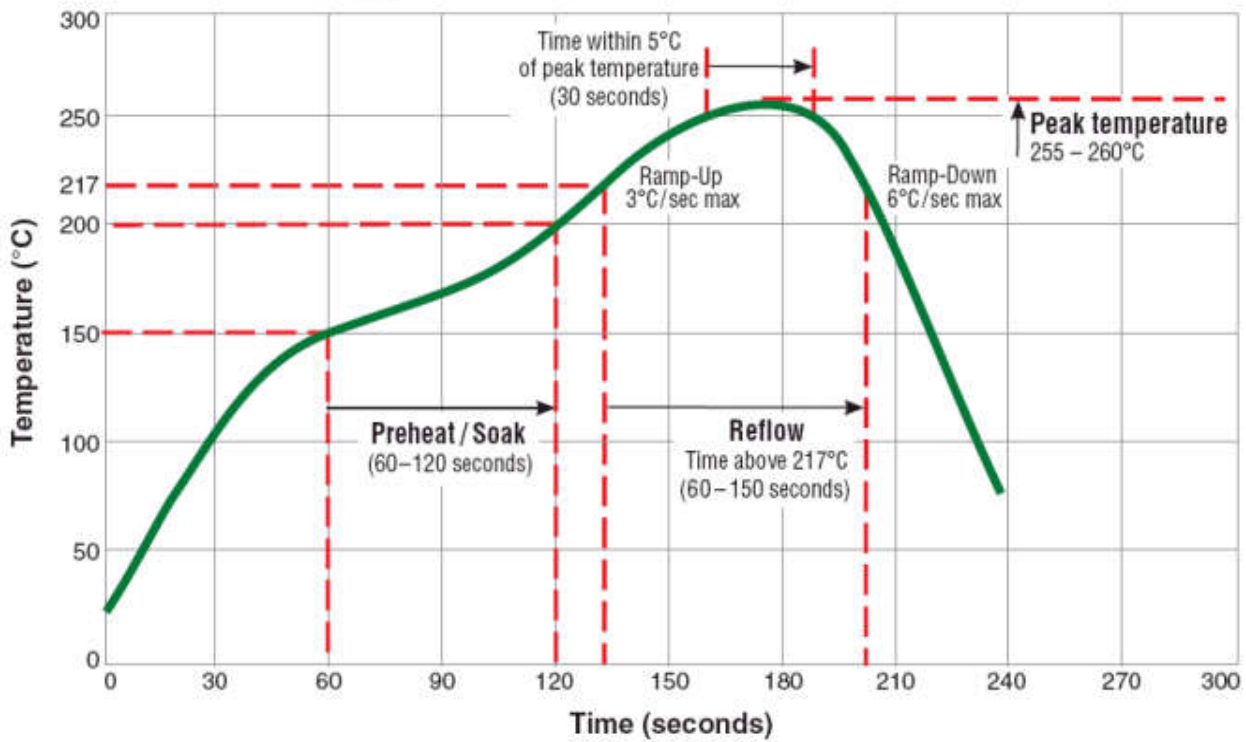

Packaging Dimension For Caeier Tape(UNIT:mm):

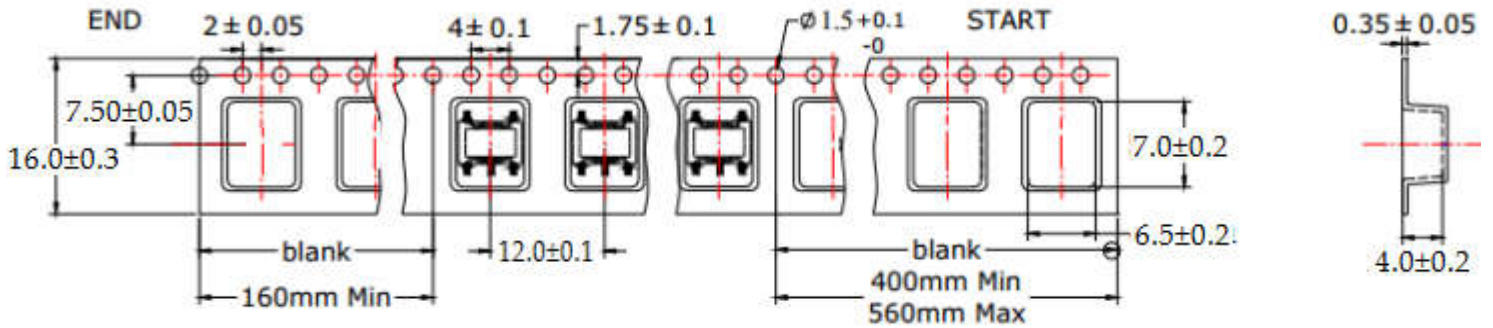

QUANTITY
1000PCS/Reel
3Reels/Middle Carton Middle Carton:
4 Middle Cartons/Big Carton
12000PCS/ Big Carton

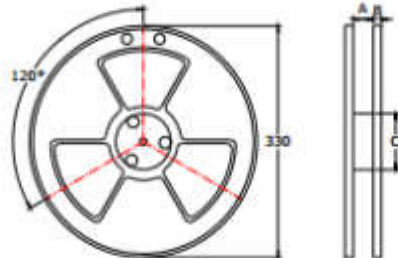

SPEC	8	12	16	24
DIM A±0.1	8.5	12.5	16.5	24.5
DIM B±0.1	2.3	2.3	2.3	2.3
DIM C±0.1	100	100	100	100

