

Features::

- ◆ 1:1.33 Impedance Ratio
- ◆ 75Ω Impedance
- ◆ Frequency: 1.0to 250.0 MHz
- ◆ RF power: 0.25W
- ◆ DC current: 30mA
- ◆ Operating temperature range: -40°C to +85°C
- ◆ Storage temperature range: -55°C to +100°C

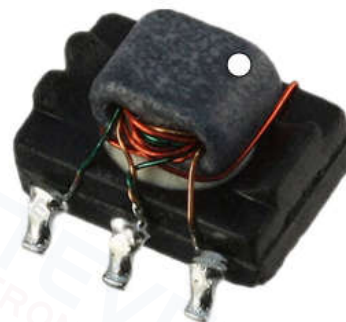

Applications:

- ◆ For broadband and wireless communications
- ◆ For functional isolation

Dimension Diagram (Unit:mm) :

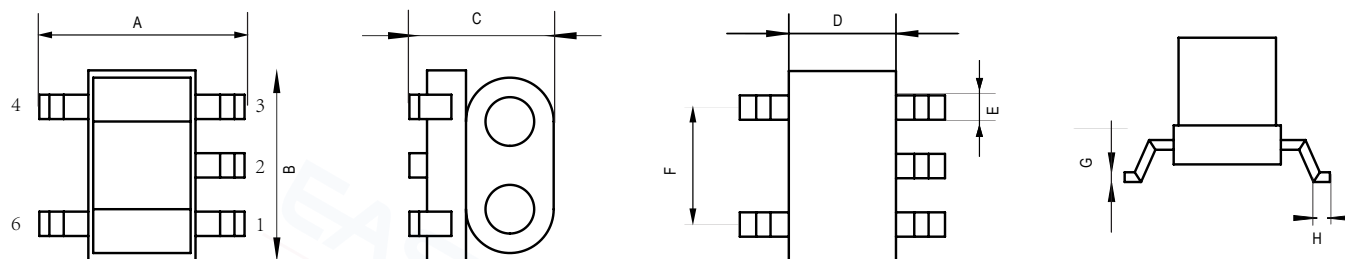

A=5.10±0.20 B=4.30±0.20 C=4.20±0.20 D=2.80±0.20 E=0.50±0.10 F=3.00±0.10 G=0.40±0.10 H=0.80±0.10

Electrical structure:

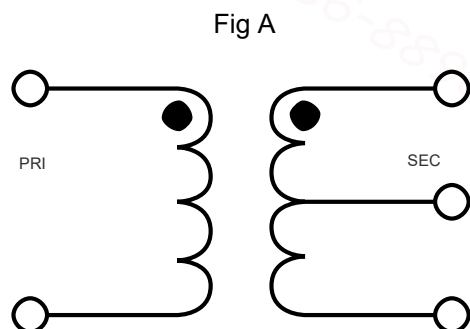

Recommended layout:

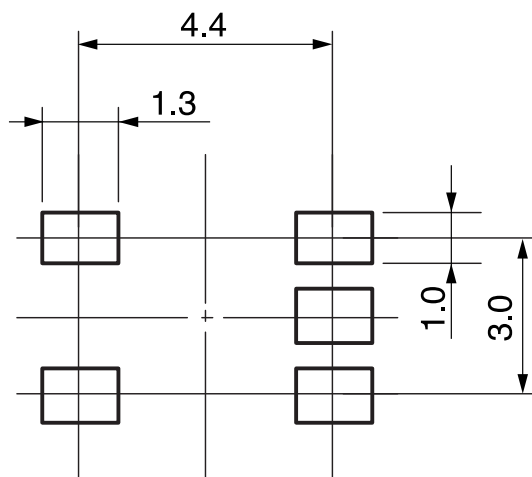

Pin configuration:

Pin No.	Function
1	Output2
2	Ground
3	Output1
4	Input
6	Ground

Application circuit :

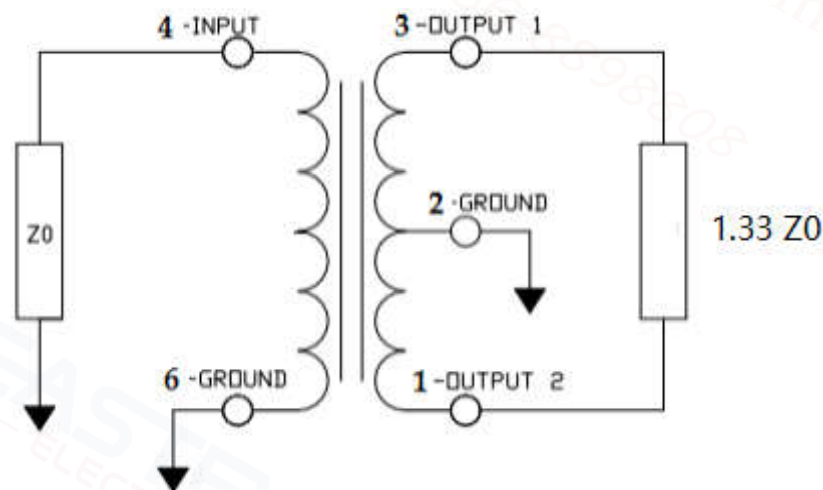

Electrical Specifications: TA=25 0dBm,Z0=75Ω:

Parameter	Test Conditions	Units	Min	Typ	Max
Main line Loss(out1)	1.0-125MHz	dB	—	0.40	1.0
	125-250MHz	dB	—	0.70	1.5
Main line Loss(out2)	1.0-250MHz	dB	—	0.35	1.0
Amplitude Balance	1.0-125MHz	dB	—	±0.10	±0.5
	125-250MHz	dB	—	±0.40	±0.7
Phase Balance	1.0-125MHz	Degrees	—	±2.0	±5.0
	125-250MHz	Degrees	—	±3.0	±7.0
Input Return Loss	1.0-125MHz	dB	18.0	27.0	—
	125-250MHz	dB	16.0	23.0	—

Main line Loss(out1)

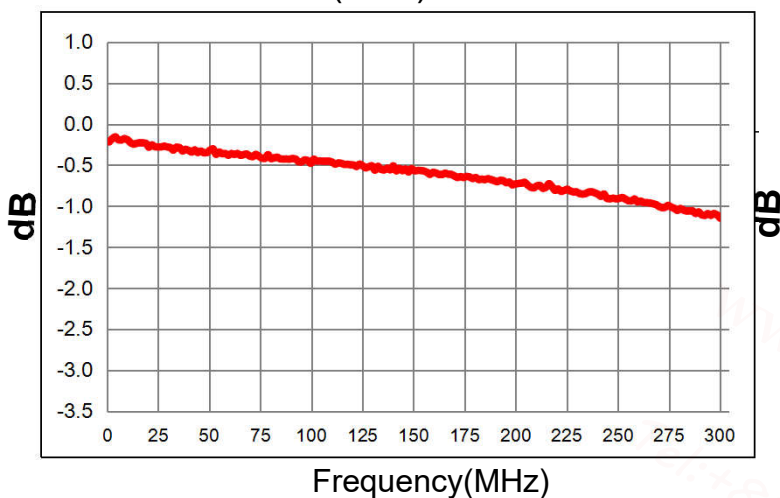

Main line Loss(out2)

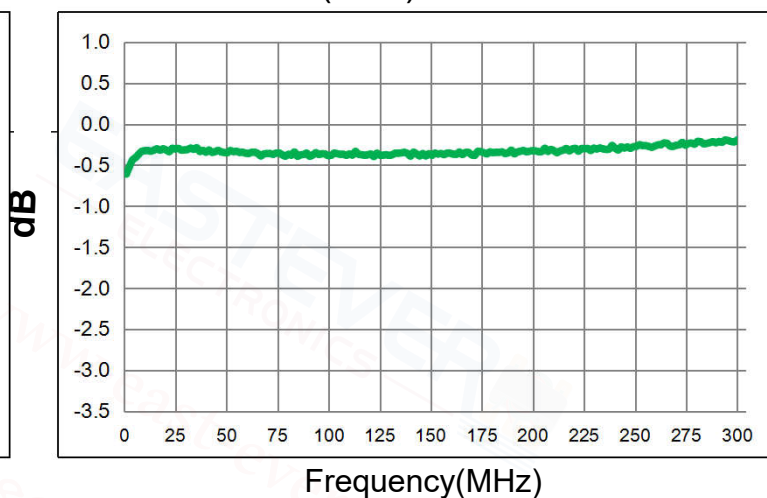

Amplitude Balance

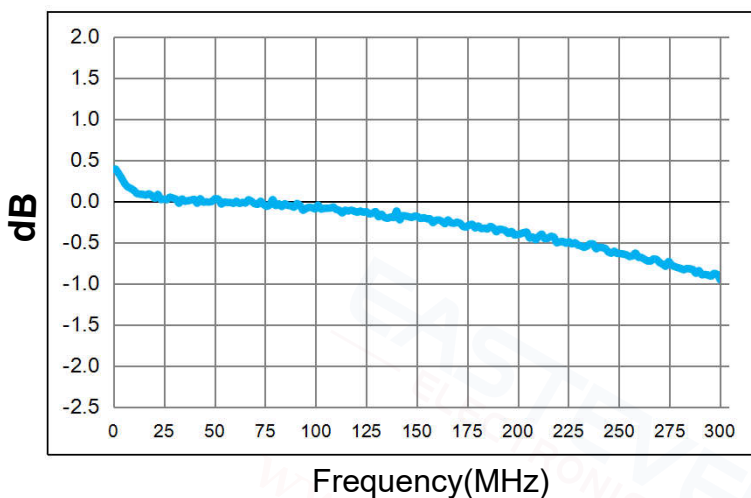

Phase Balance

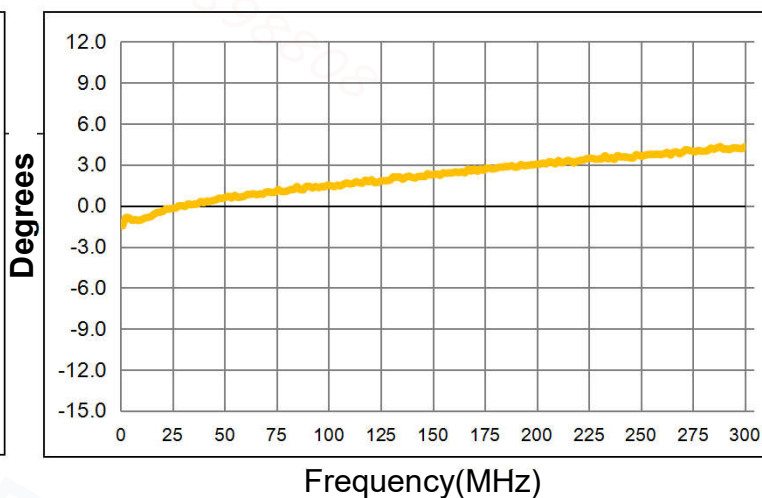

Input Return Loss

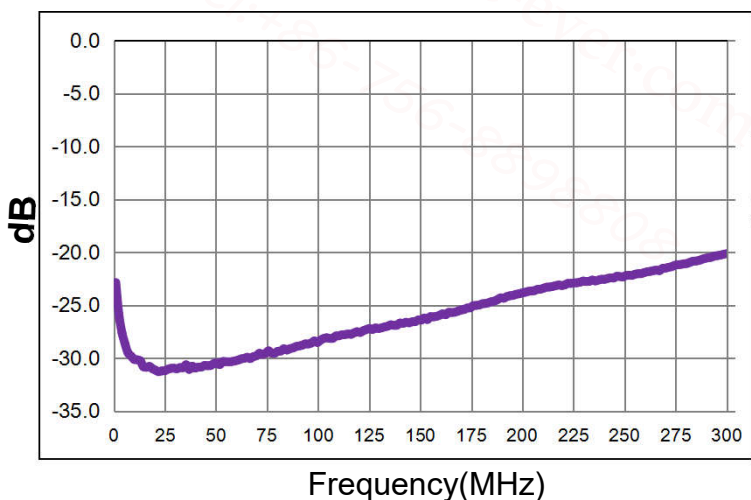

Recommended Soldering Temperature Graph:

Typical RoHS Reflow Profile

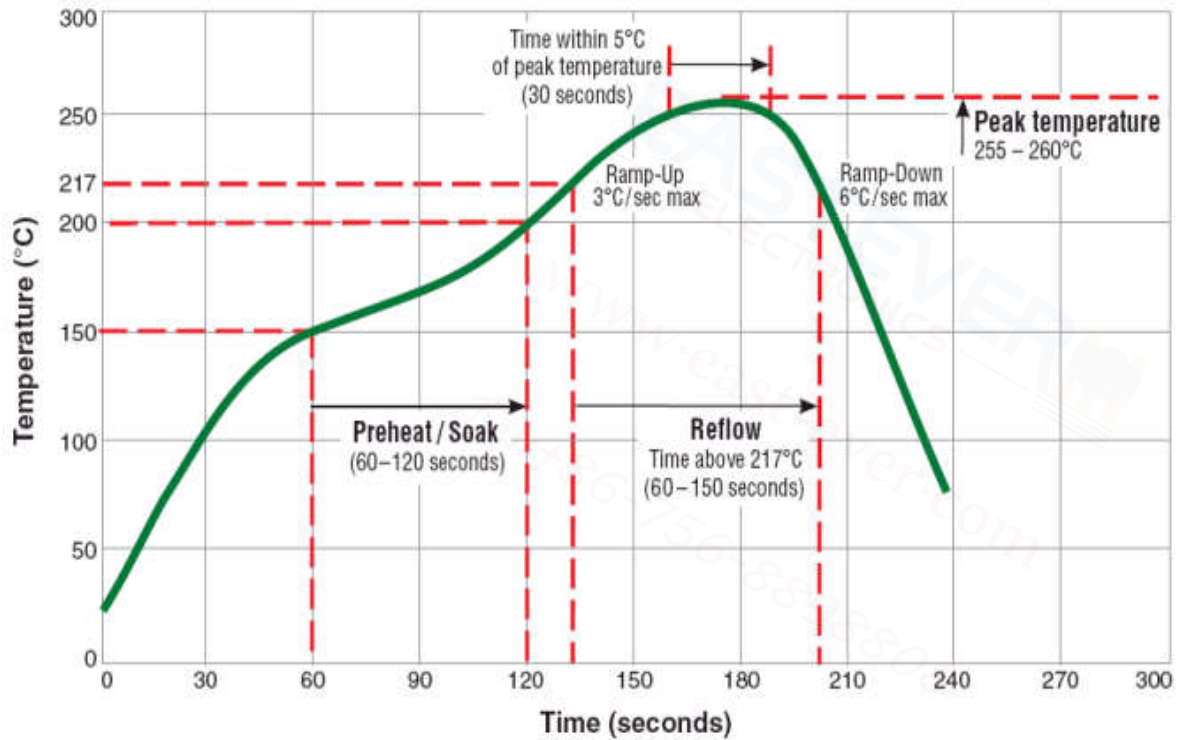

Packing Dimension For Caeier Tape(UNIT:mm):

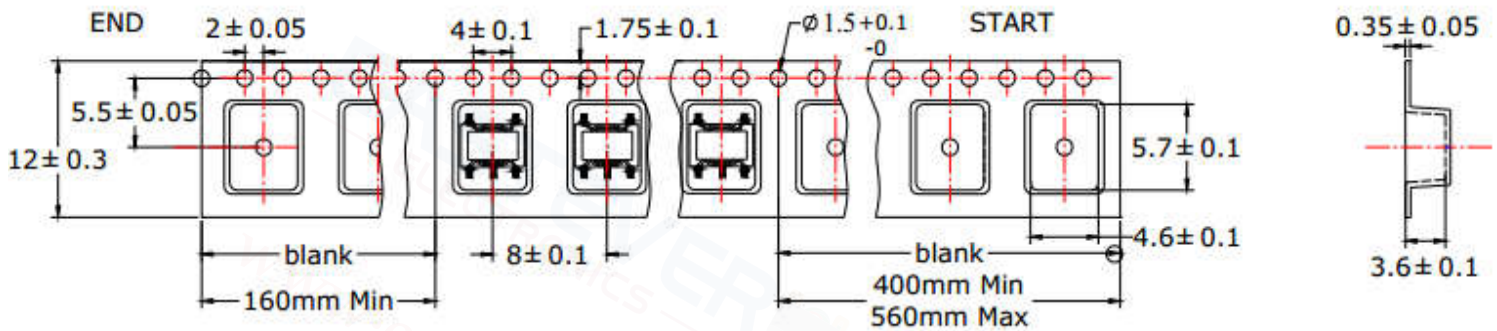

QUANTITY
2000PCS/Reel
4 Reels/Middle Carton Middle Carton:
4 Middle Cartons/Big Carton
32000PCS/ Big Carton

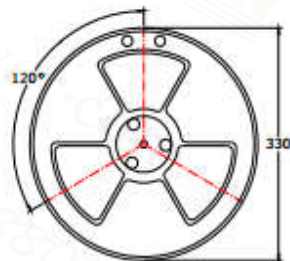

SPEC	8	12	16	24
DIM A±0.1	8.5	12.5	16.5	24.5
DIM B±0.1	2.3	2.3	2.3	2.3
DIM C±0.1	100	100	100	100

