

Features::



- ◆ 75Ω Characteristic Impedance
- ◆ Frequency: 5 to 3000 MHz
- ◆ RF power: 0.25W
- ◆ DC current: 30mA
- ◆ Operating temperature range: -40°C to +85°C
- ◆ Storage temperature range: -55°C to +100°C



Applications:

- ◆ For broadband and wireless communications
- ◆ For VHF/UHF receivers/transmitters and push-pull amplifiers

Dimension Diagram (Unit:mm) :

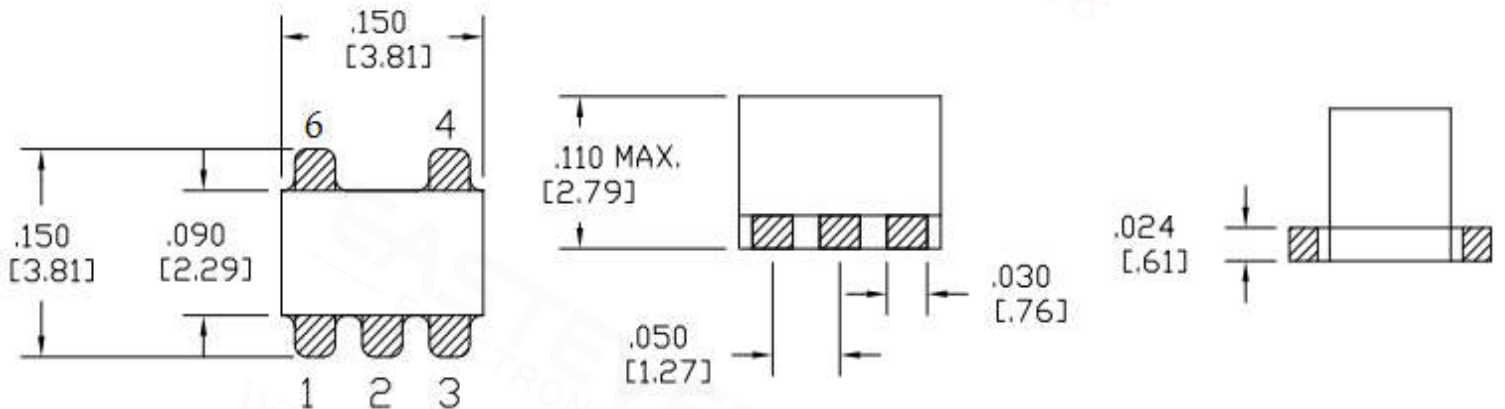

Electrical structure:

Recommended layout:

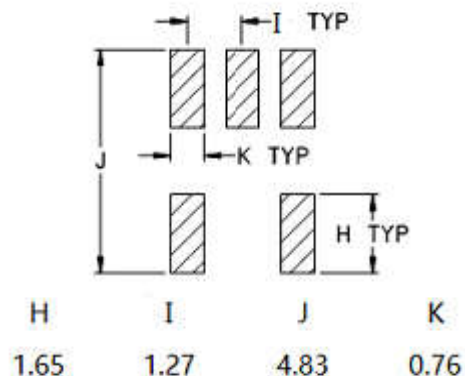
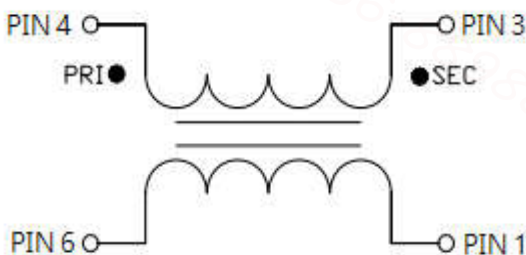

Pin configuration:

Pin no.	Function
1	Secondary (Output 2)
2	Not connected
3	Secondary dot (Output 1)
4	Primary dot (Input)
6	Primary (Ground)

Application circuit :

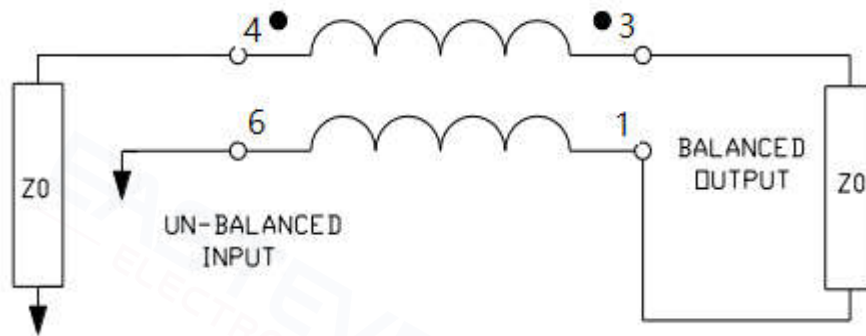

Electrical Specifications: TA=25°C, 0dBm, Z0=75Ω:

Parameter	Test Conditions	Units	Min	Typ	Max
Main line Loss(out1)	5-3000MHz	dB	—	1.7	3.5
Main line Loss(out2)	5-3000MHz	dB	—	1.5	3.5
Amplitude Balance	5-3000MHz	dB	—	±0.5	±1.0
Phase Balance	5-3000MHz	Degrees	—	±2.0	±18.0
Input Return Loss	5-3000MHz	dB	6.0	25.0	—

Main line Loss(out1)

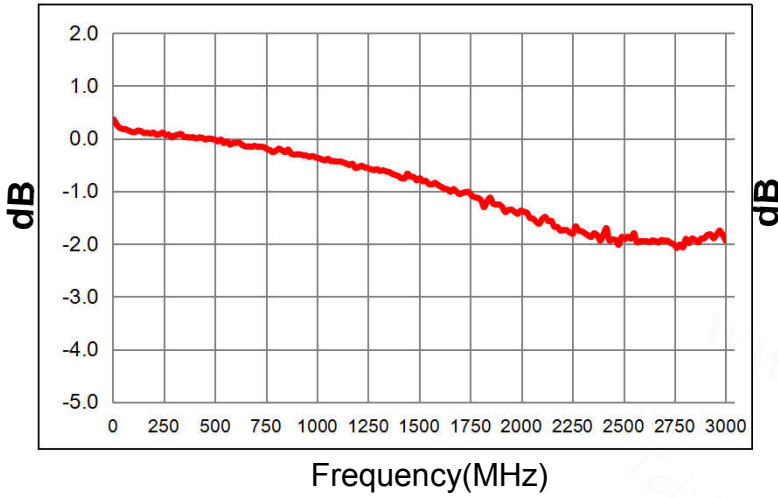

Main line Loss(out2)

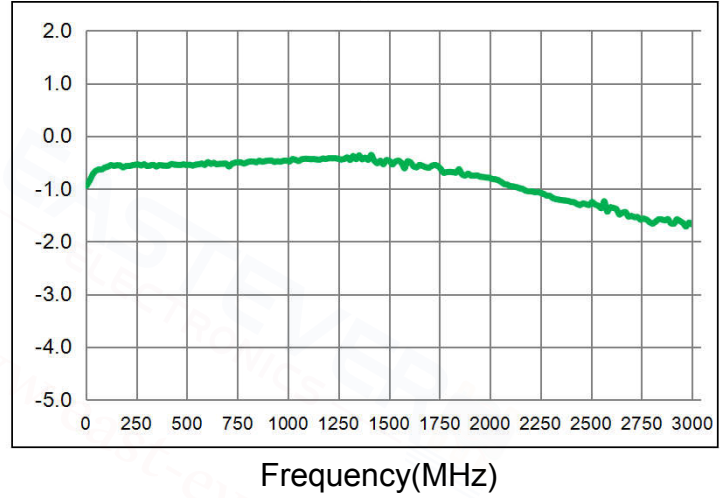

Amplitude Balance

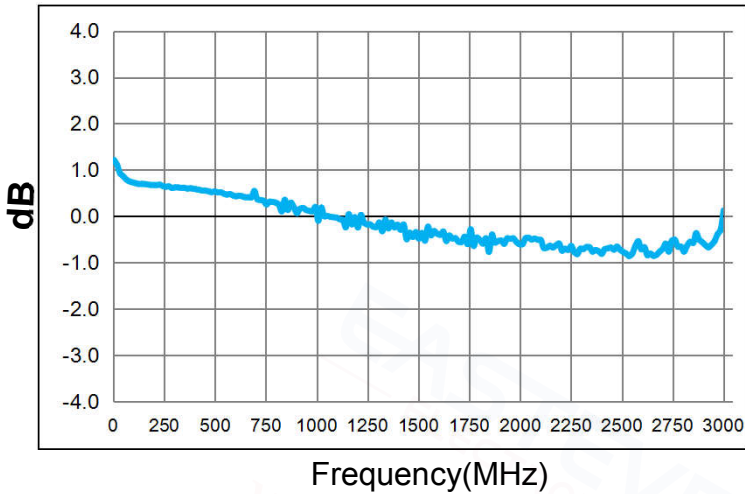

Phase Balance

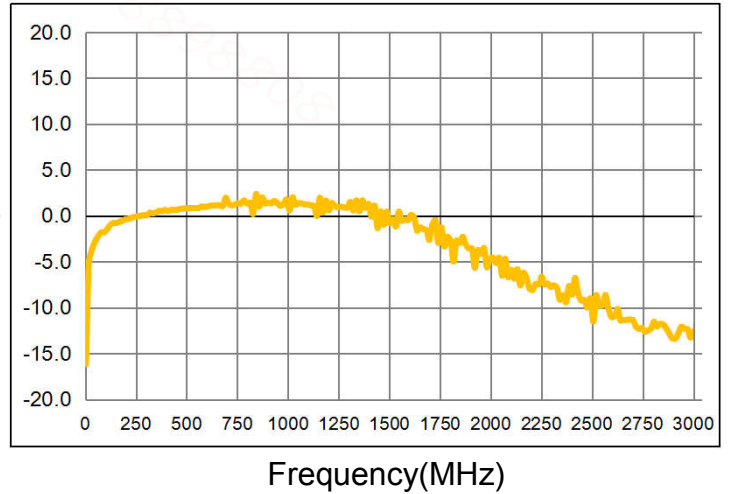

Input Return Loss

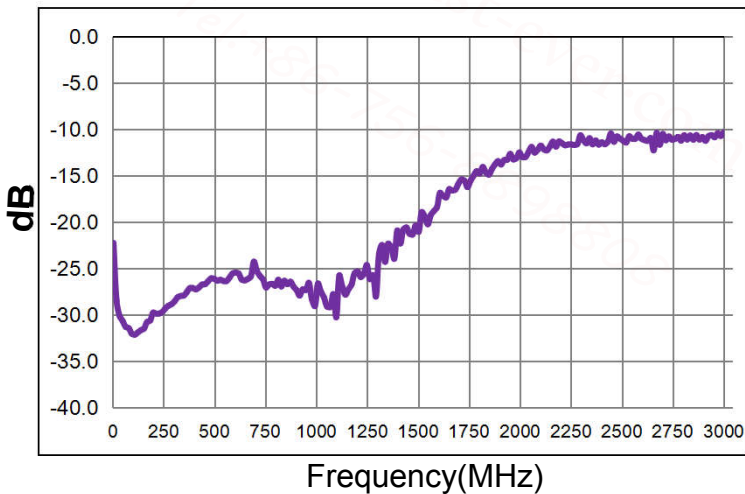

Recommended Soldering Temperature Graph:

Typical RoHS Reflow Profile

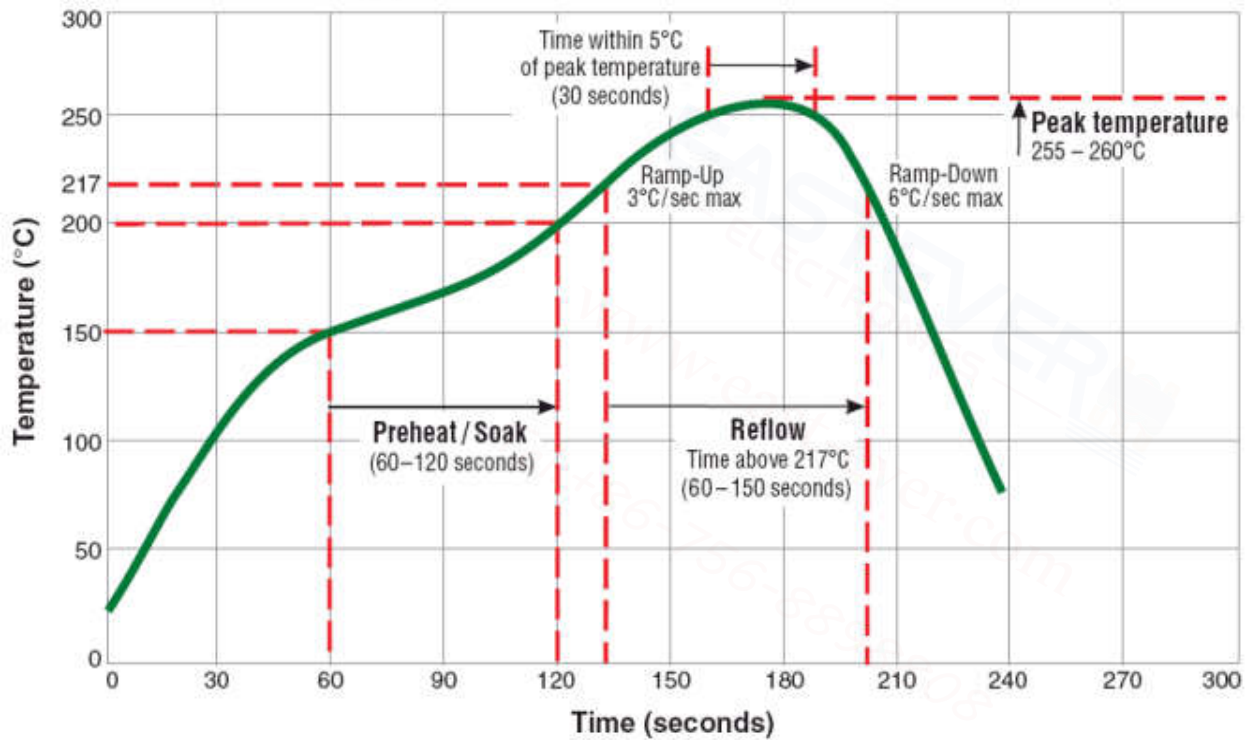

Packging Dimension For Caeier Tape(UNIT:mm):

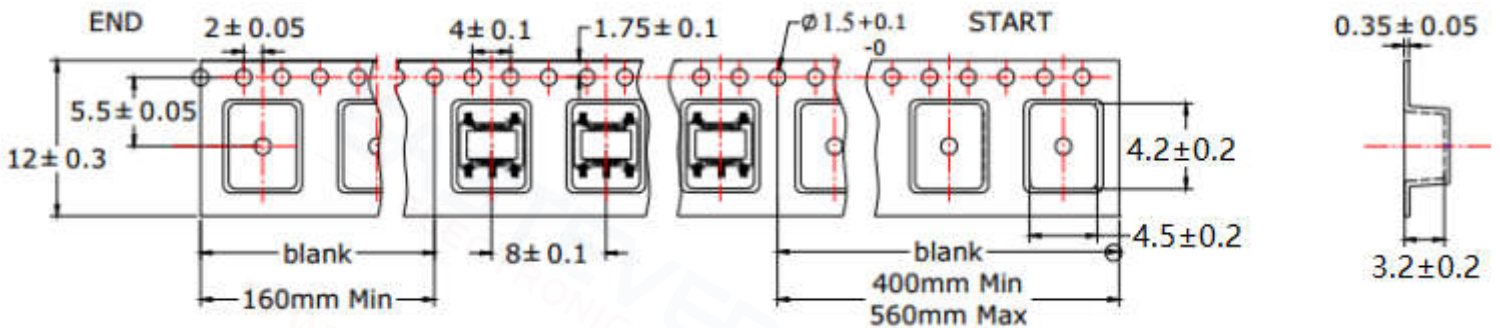

QUANTITY
2000PCS/Reel
4 Reels/Middle Carton Middle Carton:
4 Middle Cartons/Big Carton
32000PCS/ Big Carton

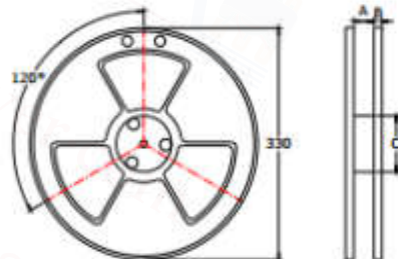

SPEC	8	12	16	24
DIM A±0.1	8.5	12.5	16.5	24.5
DIM B±0.1	2.3	2.3	2.3	2.3
DIM C±0.1	100	100	100	100

