

## Features:

- ◆ 2 Way-0° Power Splitter/Combiner
- ◆ 50Ω Impedance
- ◆ Power Input(as a splitter): 0.25W
- ◆ DC current: 30mA
- ◆ Operating temperature range: -40°C to +85°C
- ◆ Storage temperature range: -55°C to +100°C



## Applications:

- ◆ For all CATV Broadband and FTTx applications
- ◆ For VHF/UHF receivers/transmitters and push-pull amplifiers

## Dimension Diagram (Unit:mm) :

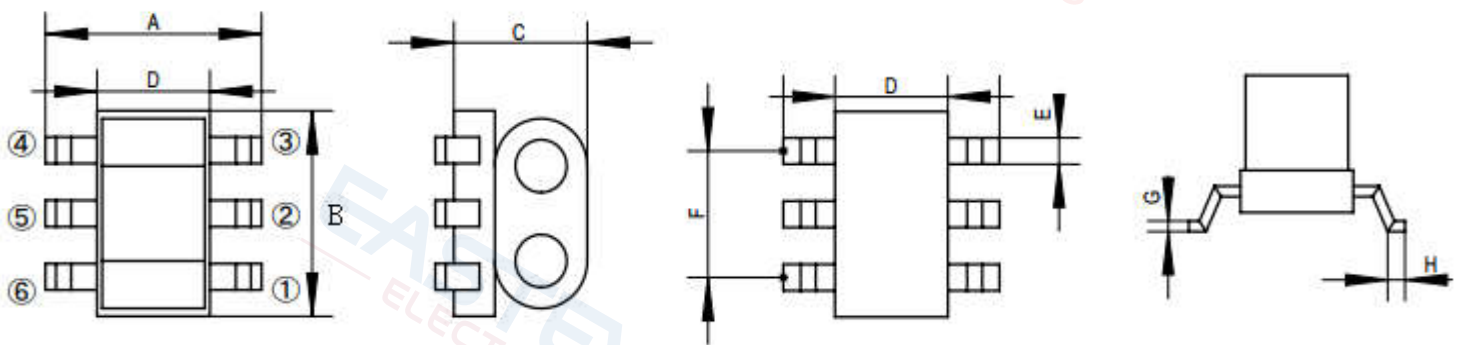

A=5.10±0.20 B=4.30±0.20 C=3.20±0.20 D=2.80±0.20 E=0.50±0.10 F=3.00±0.10 G=0.25±0.10 H=0.50±0.10

## Electrical structure:

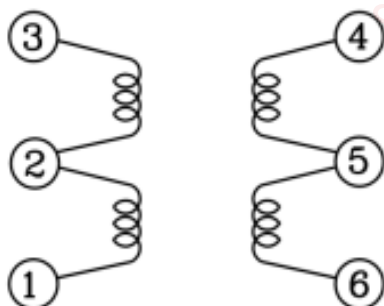

## Recommended layout are inches [mm]:

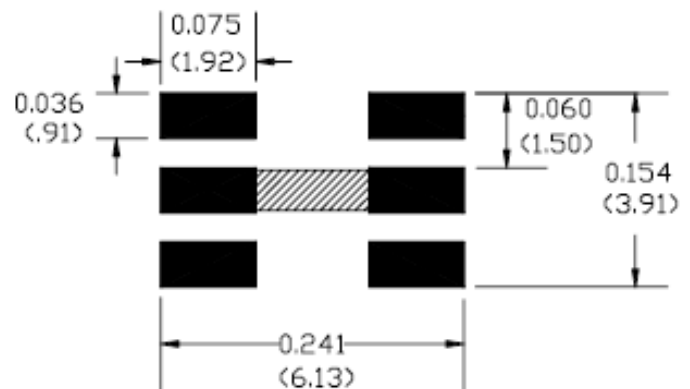

**Pin configuration:**

Pin No	Function
1	Input
4	Output 1
6	Output 2
3	Ground
4、6	EXE.RESISTOR 100Ω
2、5	EXE.CAPACITOR 2pF

**Application circuit :**

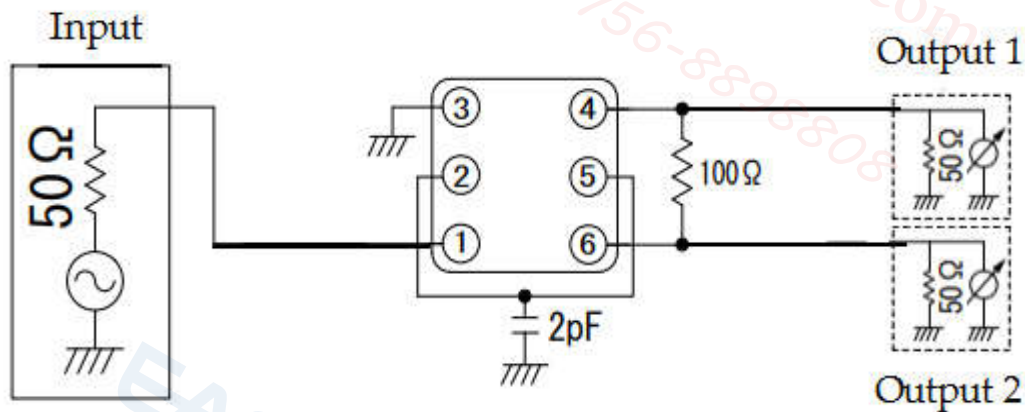

**Electrical Specifications: TA=25℃, 0dBm,Z0=50Ω**

Parameter	Test Conditions	Units	Min	Typ	Max
Main line Loss(out1)	3-10MHz	dB	—	4.0	6.0
	10-100MHz	dB	—	3.5	5.5
	100-100MHz	dB	—	4.2	6.5
Main line Loss(out2)	3-10MHz	dB	—	4.5	6.0
	10-100MHz	dB	—	3.8	5.5
	100-100MHz	dB	—	4.2	6.5
Input Return Loss	3-1000MHz	dB	8.0	25.0	—
Output 1 Return Loss	3-1000MHz	dB	10.0	25.0	—
Output 2 Return Loss	3-1000MHz	dB	10.0	30.0	—
Isolation	3-1000MHz	dB	19.0	28.0	—

### Main line Loss(Output1)

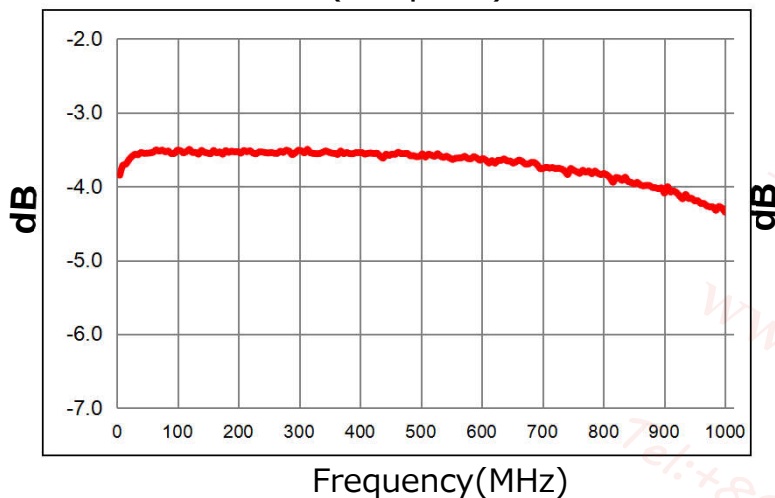

### Isolation(Pin4-6)

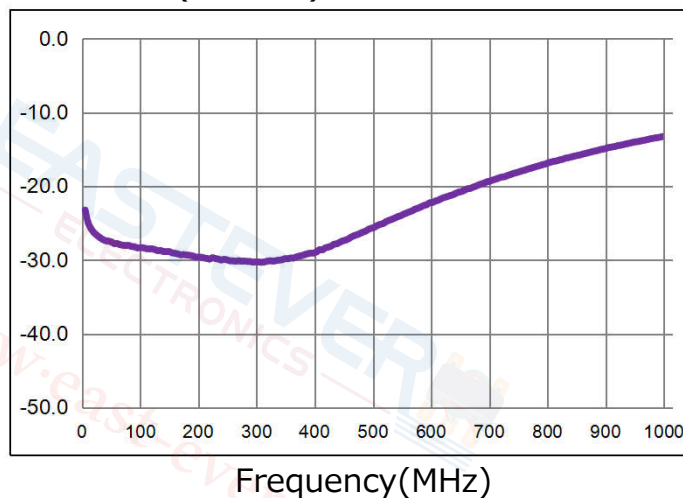

### Main line Loss(Output2)

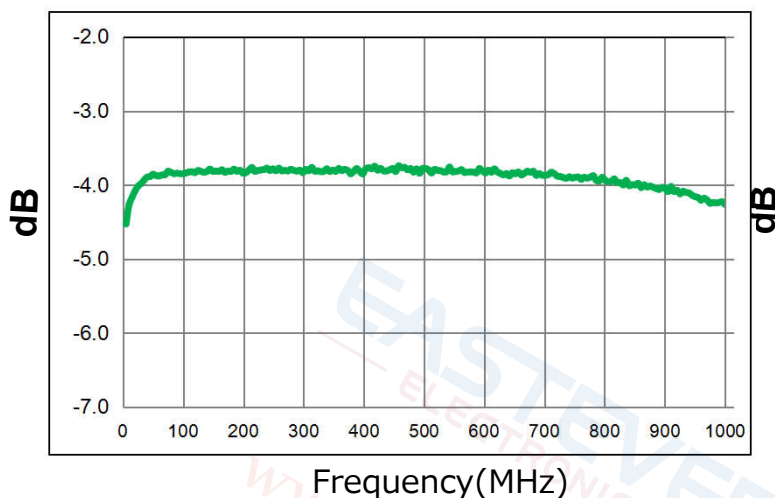

### Input Return Loss(Pin1)

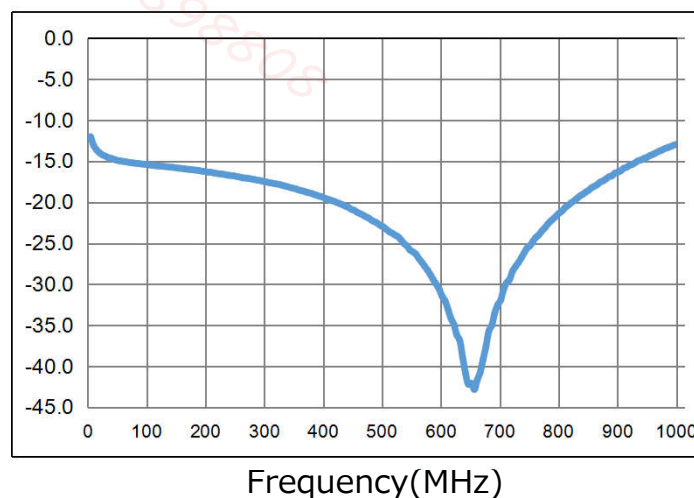

### Output 1 Return Loss(Pin4)

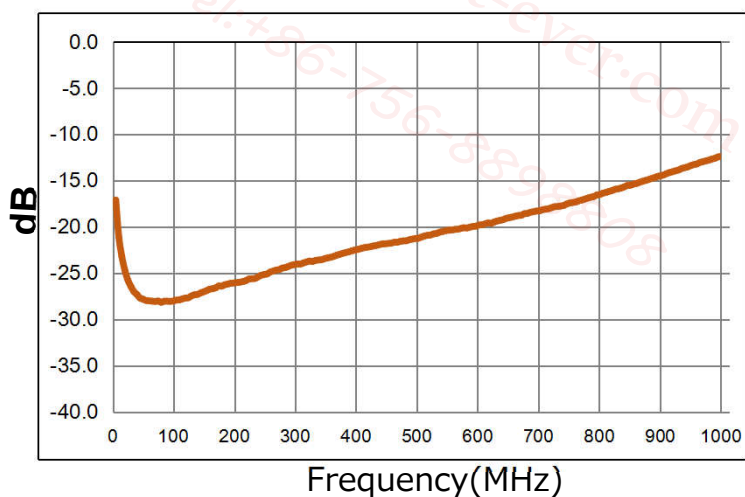

### Output 2 Return Loss (Pin6)

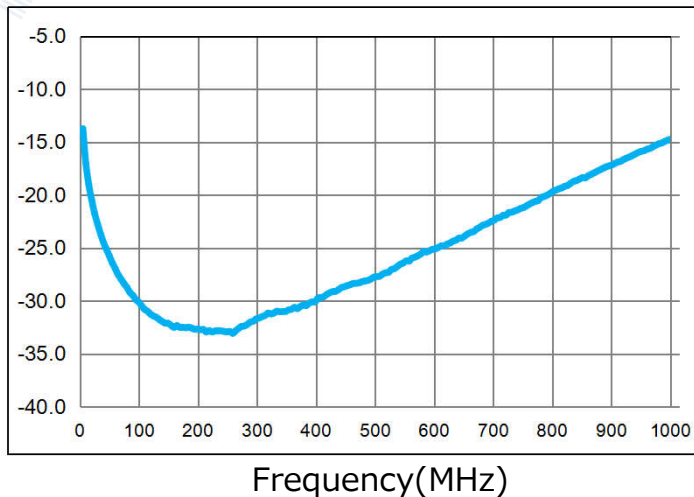

Network Analyzer Test Data Sheet Photos:

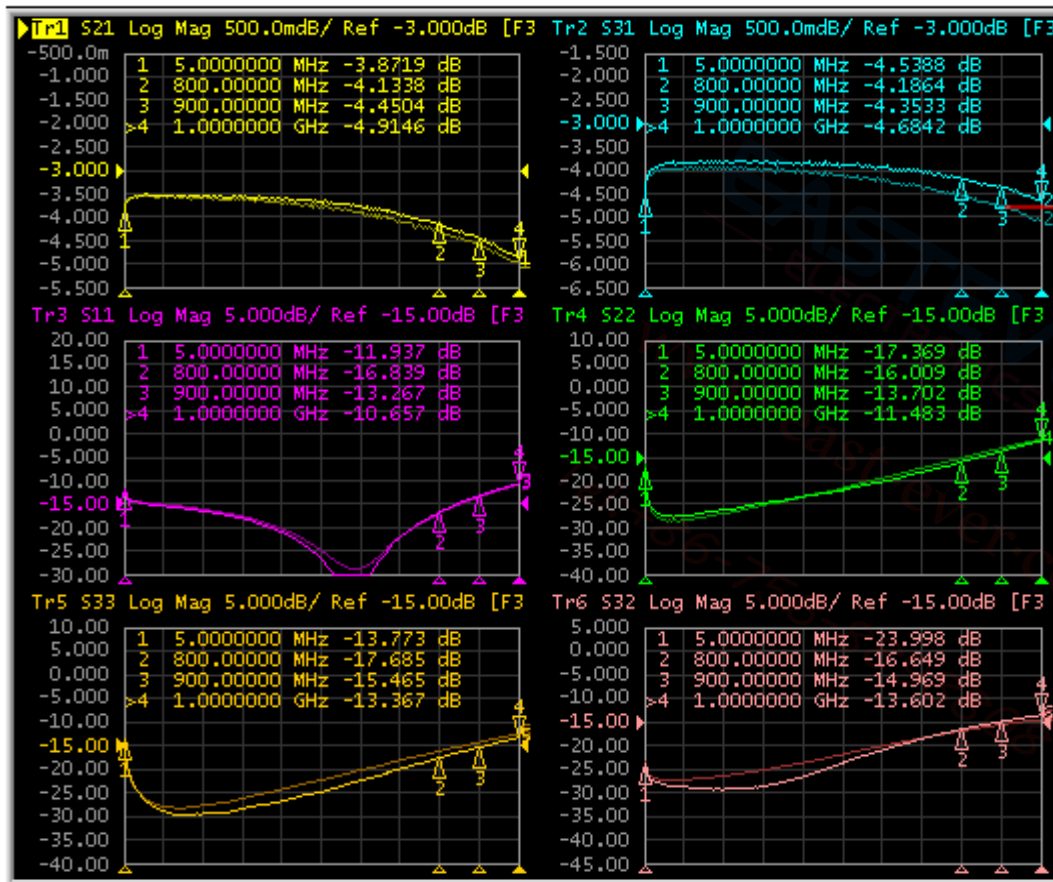

Murata Sample

Packing Dimension For Caeier Tape(UNIT:mm):

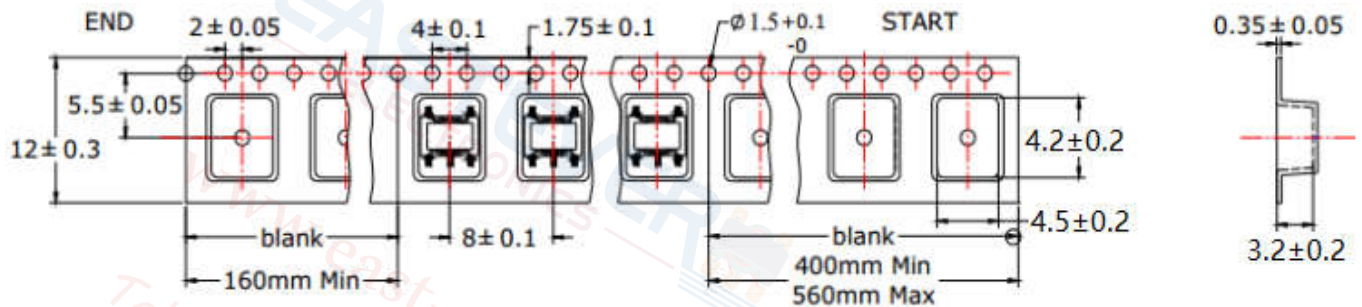

QUANTITY
2000PCS/Reel
4Reels/Middle Carton Middle Carton:
4 Middle Cartons/Big Carton
32000PCS/ Big Carton

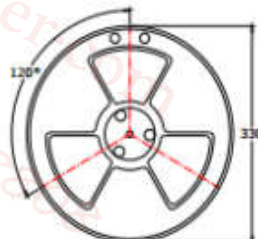

SPEC	8	12	16	24
DIM A±0.1	8.5	12.5	16.5	24.5
DIM B±0.1	2.3	2.3	2.3	2.3
DIM C±0.1	100	100	100	100

