

Features:

- ◆ Frequency Range: 5 to 1250 MHz
- ◆ Surface mount and available in tape and reel
- ◆ 260°C reflow compatible
- ◆ RoHS Compliant and Pb free
- ◆ Operating temperature range: -40°C to +85°C
- ◆ Storage temperature range: -55°C to +100°C



Applications:

- ◆ For catv
- ◆ For broadband and wireless communications

Dimension diagram (Unit:mm) :

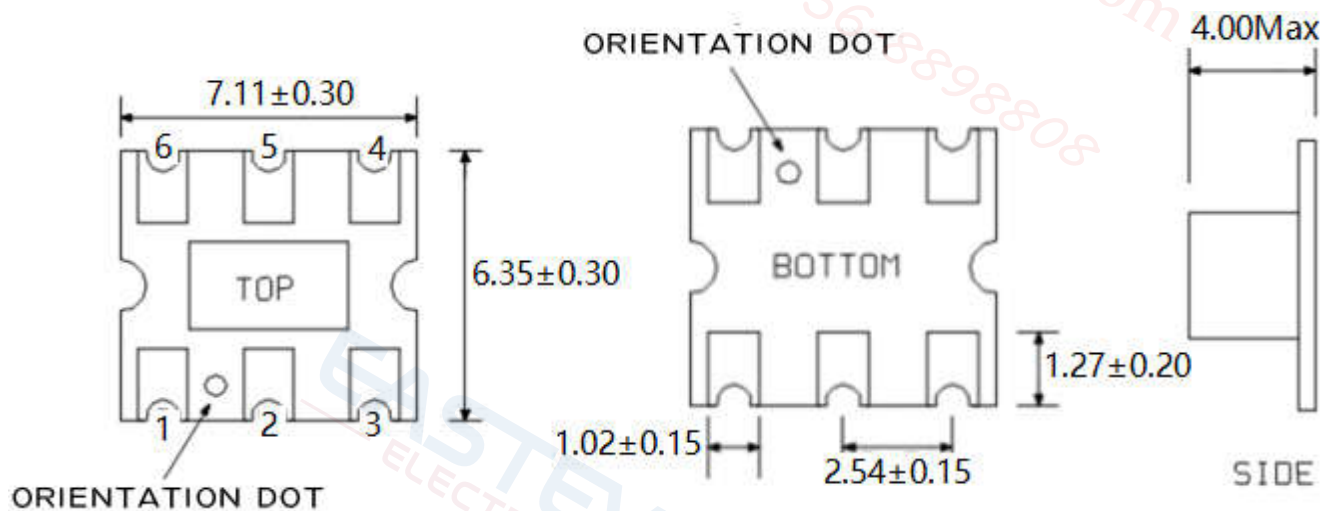

Electrical structure:

Recommended layout(mm):

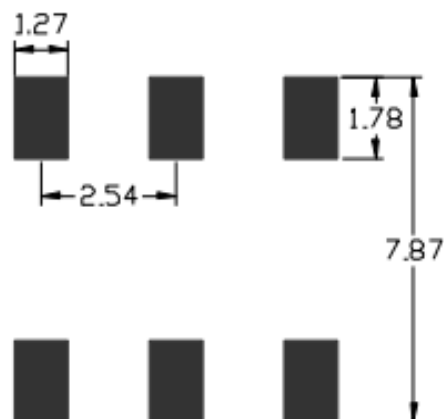
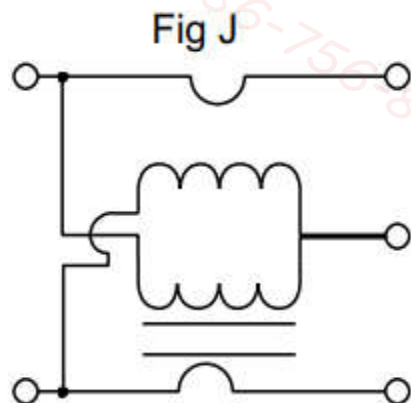

Pin configuration:

Pin No.	Function
1	Input
2	Ground
3	Coupled
4	Isolated
6	Output

Application circuit :

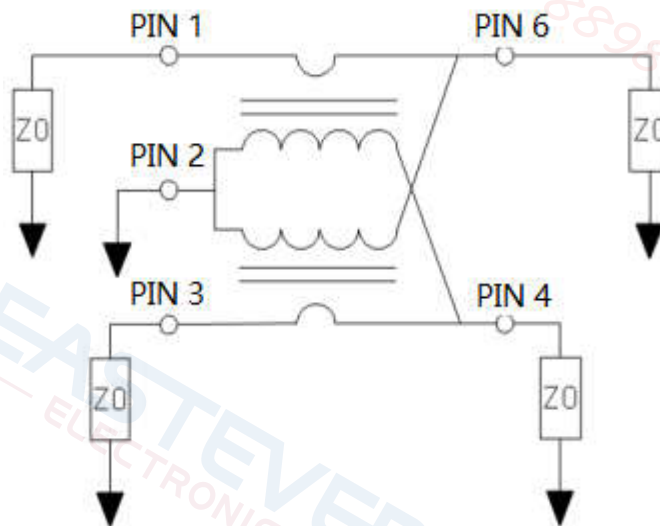

Electrical Specifications: TA=25°C, 0dBm, Z0=75Ω:

Parameter	Test Conditions	Units	Min	Typ	Max
Main line Loss	5-1250MHz	dB	—	0.35	1.0
Coupling	5-1250MHz	dB	—	19.0	±1.0
Input Return Loss	5-1250MHz	dB	20.0	28.0	—
Output Return Loss	5-1250MHz	dB	20.0	32.0	—
Coupling Return Loss	5-1250MHz	dB	20.0	30.0	—
Isolation	5-1250MHz	dB	28.0	35.0	—

Main line Loss(pin1-6):

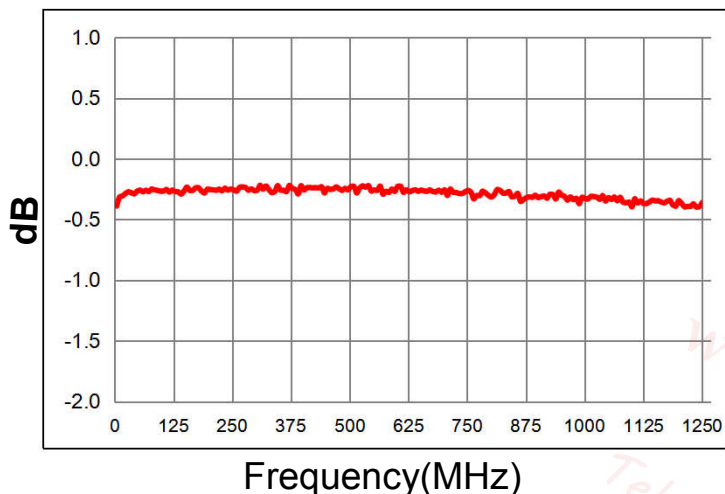

Coupling(pin1-3):

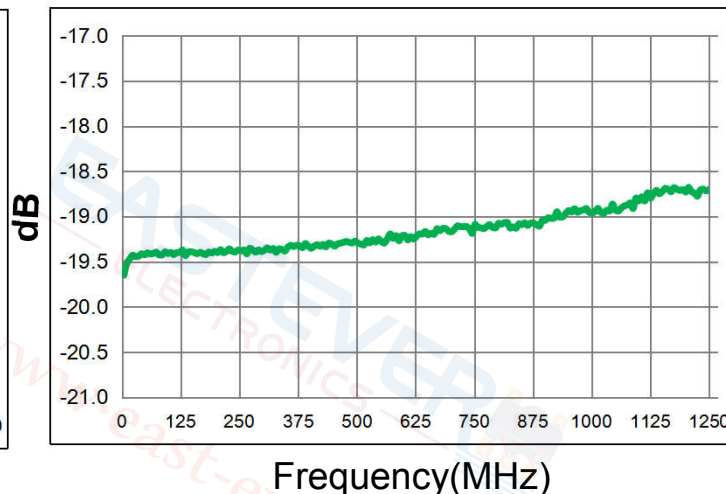

Input Return Loss (Pin1)

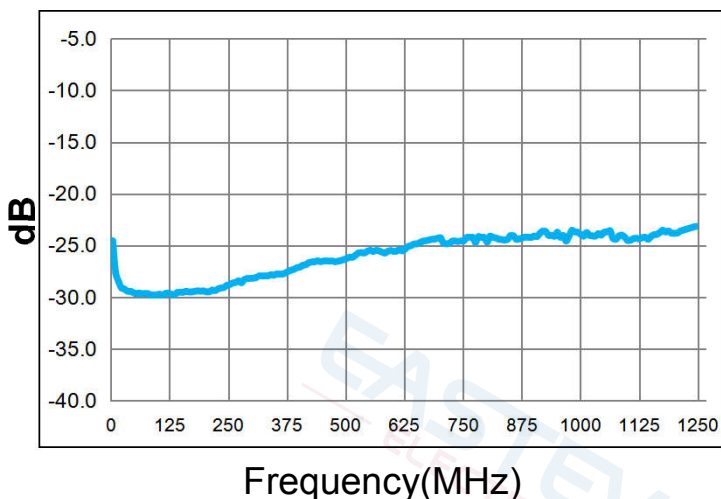

Output Return Loss (Pin6)

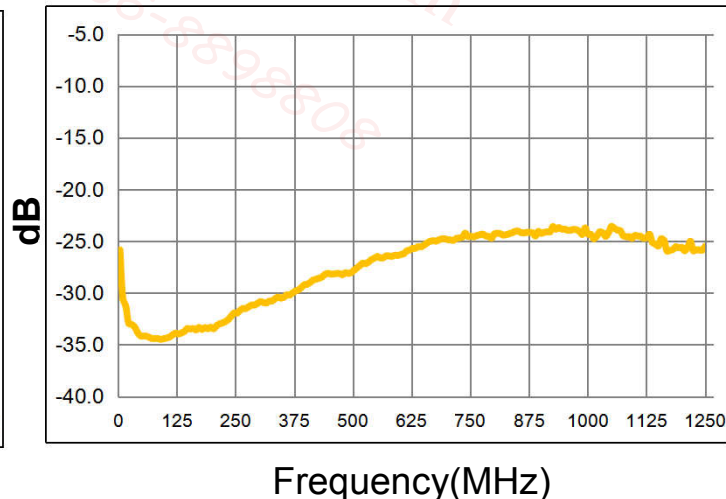

Coupling Return Loss (Pin6)

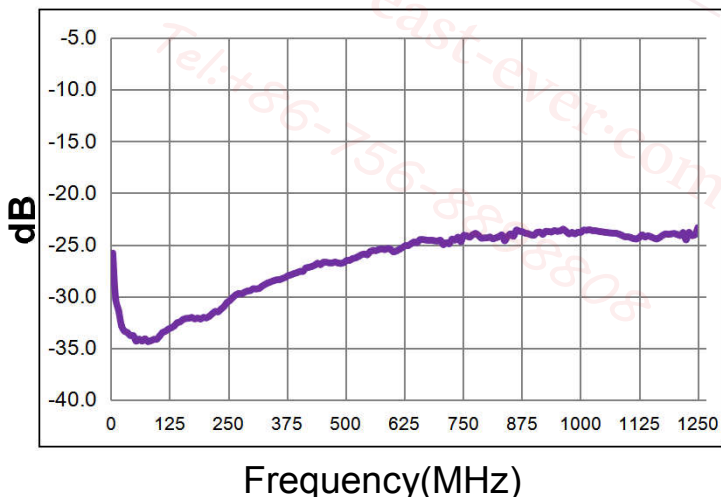

Isolation (Pin1-4)

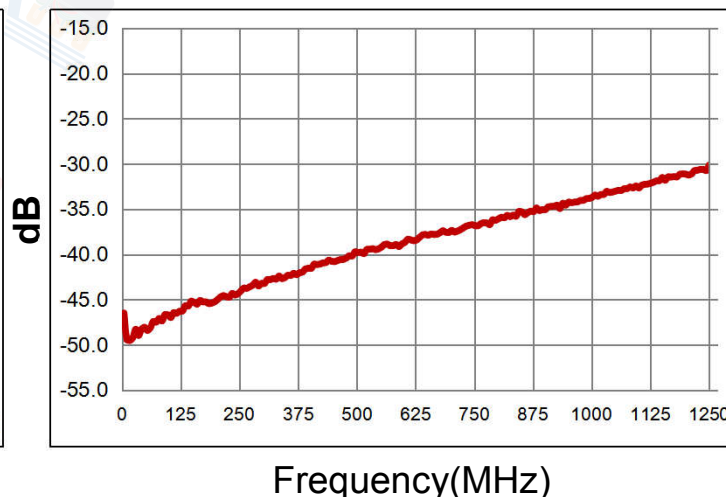

Recommended Soldering Temperature Graph:

Typical RoHS Reflow Profile

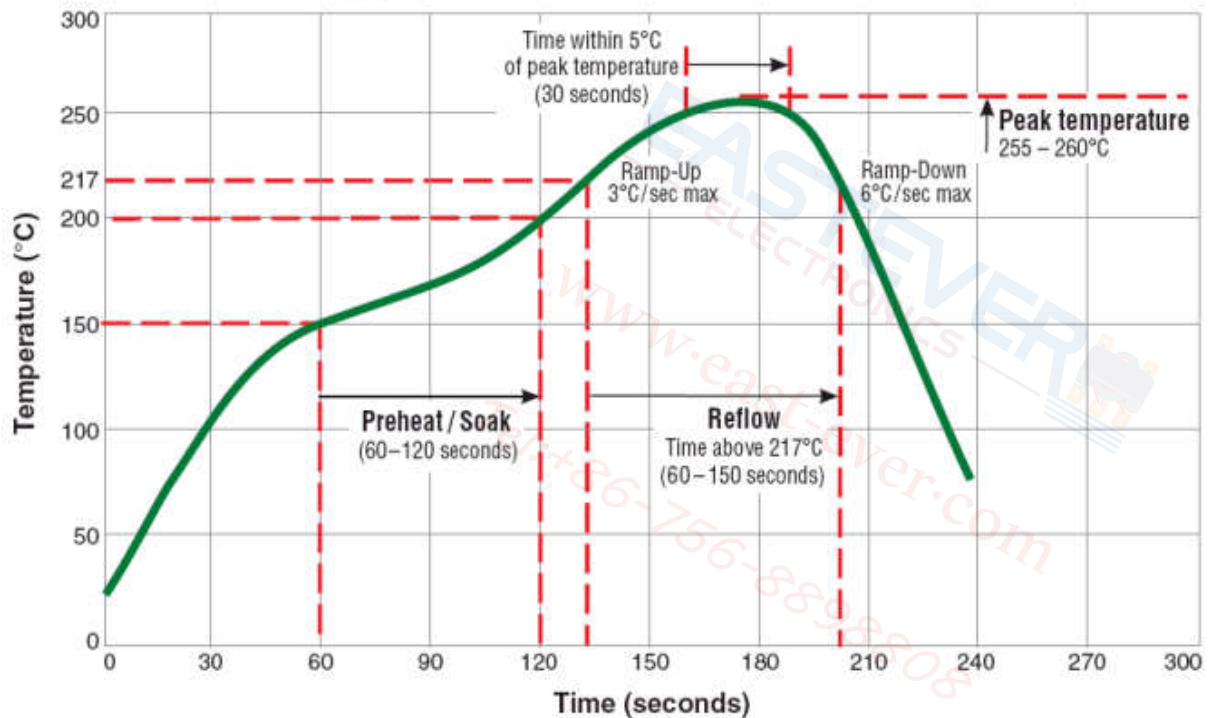

Packaging Dimension For Caeier Tape(UNIT:mm):

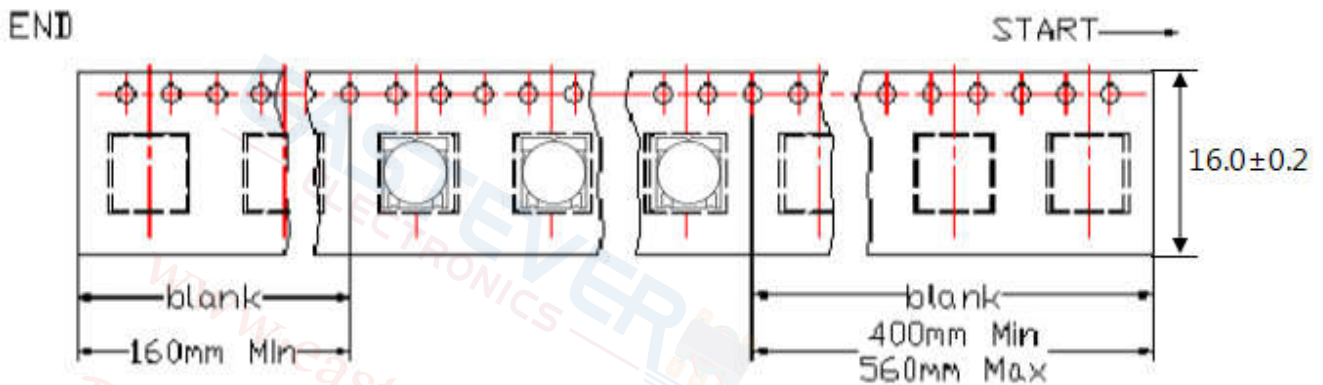

QUANTITY
1500PCS/Reel
3Reels/Middle Carton Middle Carton:
4 Middle Cartons/Big Carton
18000PCS/ Big Carton

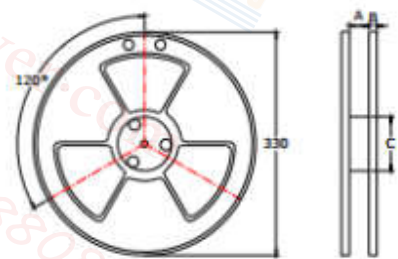

SPEC	8	12	16	24
DIM A±0.1	8.5	12.5	16.5	24.5
DIM B±0.1	2.3	2.3	2.3	2.3
DIM C±0.1	100	100	100	100

